

PARTS BREAKDOWN

B3ZQMS SAE 5 Engine Mount Water Pump (CW Groove)

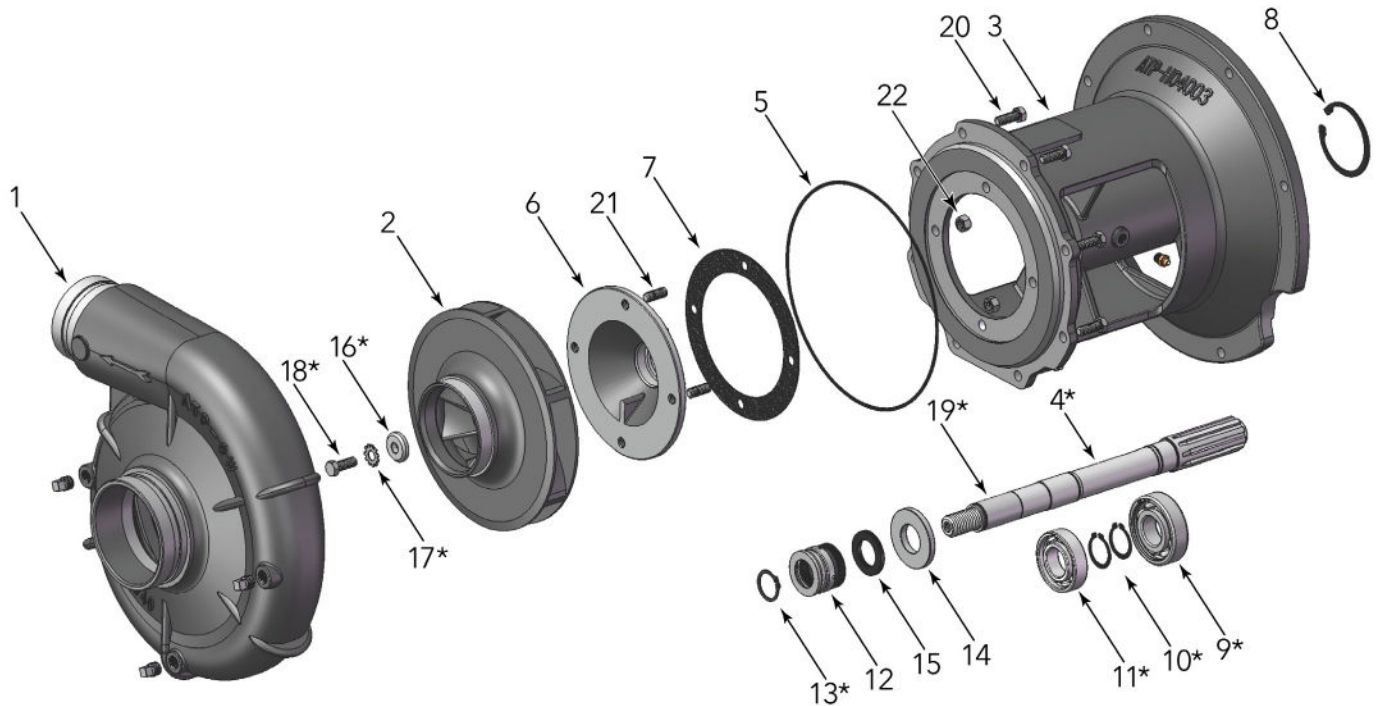

PARTS							
#	NAME	SKU	ALT SKU	#	NAME	SKU	ALT SKU
1	Volute Case, CW, Grooved	113-H04040	H04040	12	Mechanical Seal	116-S32690	S32690
2	Impeller	112-M04275	M04275	13	Seal Retaining Ring	116-S23009	S23009
3	SAE Mount Frame	114-H04003	H04003	14	Oil Seal	116-S14762	S14762
4	Shaft Kit	111-B71878	B71878	15	Water Slinger	116-S12260	S12260
5	Volute O-Ring	116-M14943	M14943	16	Impeller Washer	116-S06314	S06314
	Optional Gasket	116-S05126	S05126	17	Lock Washer	116-S23036	S23036
6	Seal Retainer	116-M06063	M06063	18	Impeller Screw, 3/8-16x1"	116-S23566	S23566
7	Gasket, Seal Retainer	116-S16800	S16800	19	Shaft Sleeve	116-S39242	S39242
8	Ring, Retaining	116-S24652	S24652	20	Capscrew, Hex 3/8-16x3/8"	116-S26825	S26825
9	Ball Bearing	116-S14059	S14059	21	Stud, 3/8-16x1 1/4"	116-S23944	S23944
10	Retaining Ring (2 Req)	116-S23010	S23010	22	Nut, Hex 3/8-16"	116-S23103	S23103
11	Ball Bearing	116-S13270	S13270		Complete Pump	101-B69963	B69963